

- **Ideal for 418.00 MHz Transmitters**
- **Very Low Insertion Loss**
- **Quartz Stability**
- **Rugged, Hermetic, Low Profile F-11 Package**

SR418B

Absolute Maximum Rating (Ta=25°C)			
Parameter		Rating	Unit
CW RF Power Dissipation	P	0	dBm
DC Voltage	V_{DC}	± 30	V
Operating Temperature Range	T_A	-10 ~ +60	°C
Storage Temperature Range	T_{stg}	-40 ~ +85	°C

Electronic Characteristics						
	Parameter	Sym	Minimum	Typical	Maximum	Unit
Frequency (25°C)	Nominal Frequency	f_C	NS	418.00	NS	MHz
	Tolerance from 418.00 MHz	Δf_C	-	-	± 150	KHz
Insertion Loss		IL	-	1.6	2.2	dB
Quality Factor	Unloaded Q-Value	Q_U	-	11,700	-	-
	50Ω Loaded Q-Value	Q_L	-	1,950	-	-
Temperature Stability	Turnover Temperature	T_O	25	-	55	°C
	Turnover Frequency	f_O	-	f_C	-	KHz
	Frequency Temperature Coefficient	FTC	-	-0.032	-	ppm/°C ²
Frequency Aging	Absolute Value during the First Year	$ f_A $	-	-	10	ppm/yr
DC Insulation Resistance Between any Two Pins		-	1.0	-	-	MΩ
RF Equivalent RLC Model	Motional Resistance	R_M	-	20.0	29.0	Ω
	Motional Inductance	L_M	-	89.1415	-	μH
	Motional Capacitance	C_M	-	1.6280	-	fF
	Pin 1 to Pin 2 Static Capacitance	C_O	1.70	1.95	2.20	pF

NS = Not Specified

Notes:

- The center frequency, f_C , is measured at the minimum IL point with the resonator in the 50Ω test system.
- Unless noted otherwise, case temperature $T_C = +25^\circ\text{C} \pm 2^\circ\text{C}$.
- Frequency aging is the change in f_C with time and is specified at +65°C or less. Aging may exceed the specification for prolonged temperatures above +65°C. Typically, aging is greatest the first year after manufacture, decreasing in subsequent years.
- Turnover temperature, T_O , is the temperature of maximum (or turnover) frequency, f_O . The nominal frequency at any case temperature, T_C , may be calculated from: $f = f_O [1 - FTC (T_O - T_C)^2]$.
- This equivalent RLC model approximates resonator performance near the resonant frequency and is provided for reference only. The capacitance C_O is the measured static (nonmotional) capacitance between Pin1 and Pin2. The measurement includes case parasitic capacitance.
- Derived mathematically from one or more of the following directly measured parameters: f_C , IL , 3 dB bandwidth, f_C versus T_C , and C_O .
- The specifications of this device are based on the test circuit shown above and subject to change or obsolescence without notice.
- Typically, equipment utilizing this device requires emissions testing and government approval, which is the responsibility of the equipment manufacturer.
- Our liability is only assumed for the Surface Acoustic Wave (SAW) component(s) per se, not for applications, processes and circuits implemented within components or assemblies.
- For questions on technology, prices and delivery please contact our sales offices or e-mail to sales@vanlong.com.

Package Dimensions (F-11)

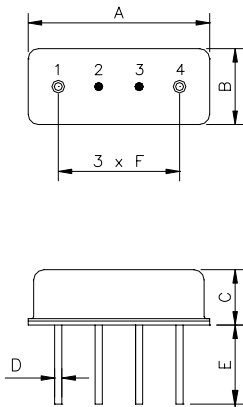

Electrical Connections

Terminals	Connection
1	Input/Output
2	Case Ground
3	Case Ground
4	Output/Input

Package Dimensions

Dimensions	Nom. (mm)	Tol. (mm)
A	11.0	±0.3
B	4.5	±0.3
C	3.2	±0.3
D	0.45	±0.1
E	5.0	±0.5
F	2.54	±0.2

Marking



Ink Marking
Color: Black or Blue

Equivalent LC Model and Test Circuit

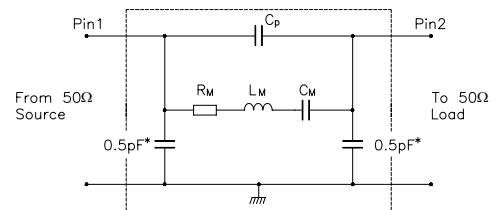

Typical Application Circuit

Low Power Transmitter Application

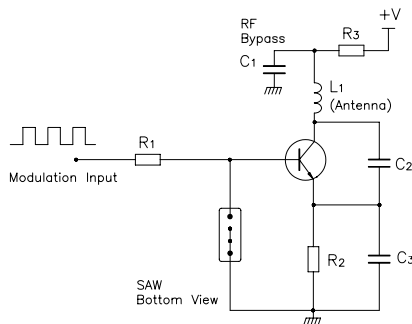

Local Oscillator Application

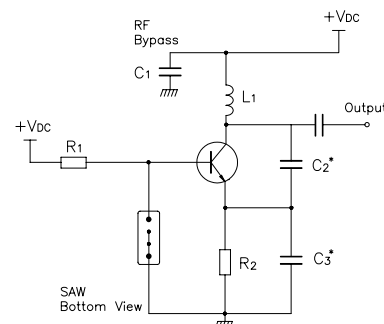

Typical Frequency Response

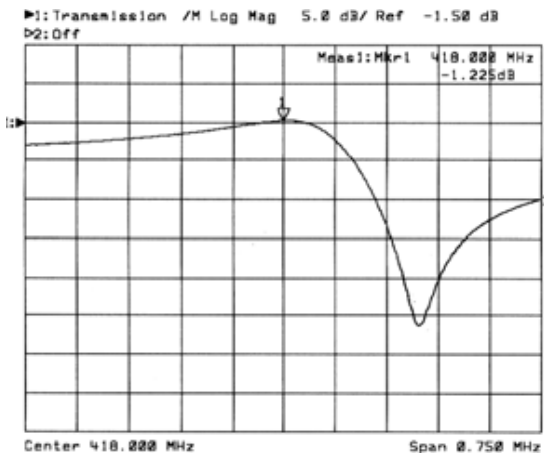

Temperature Characteristics

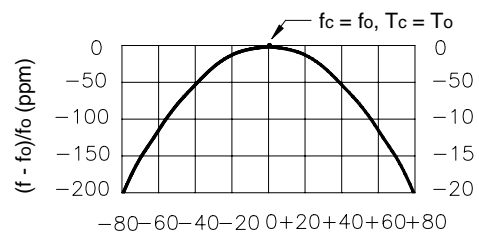

$$\Delta T = T_c - T_o \text{ (}^\circ\text{C)}$$

The curve shown above accounts for resonator contribution only and does not include oscillator temperature characteristics.